

CERROJOS

HERRAJE CASTELLANO

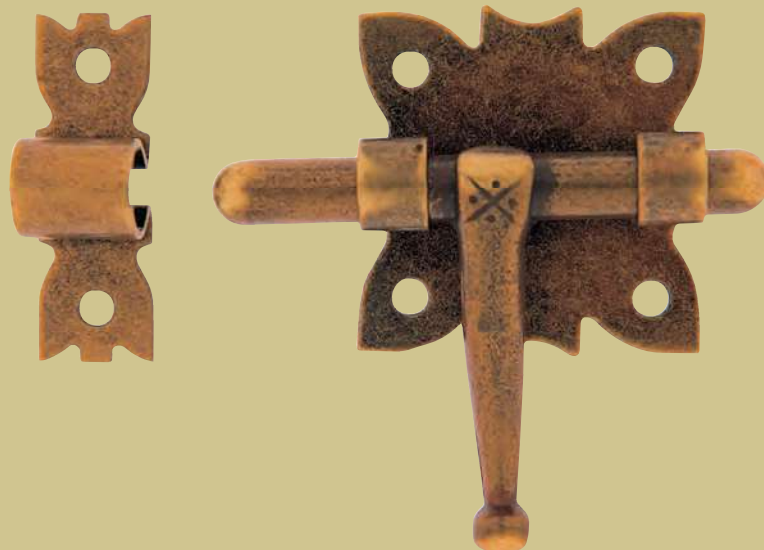

CERROJOS

Estilo 45, 45P
Estilo 84R
* Felipe II 85R

081

081

081

CERROJILLO FUERTE

* 384

082

CERROJO GIRATORIO

* 454
* 454C

082

082

CERROJO GIRATORIO PARA SOLDAR CON AGUJERO CANDADO

* 455
* 455C

082

082

Para más modelos, visita nuestro catálogo de Fragua y Grannoble; www.emiliotortajadasl.com

ACABADOS EN STOCK: 1- NEGRO CASTELLANO / A- ANTICUARIO / P- PLATA VIEJA / 9- RUSTIK / 0- PULIDO

ACABADOS BAJO PEDIDO: 7- BLANCO / 2- LATÓN BRILLO / H- LATÓN MATE / 6- NIQUEL BRILLO / N- NIQUEL MATE / L- BRONCE INGLÉS / C- COBRE BRILLO / *3- BICROMATADO / * 4- ZINCADO / * 8- ÓXIDO NATURAL / * M- FRAGUA

Estilo 45, 45P

CERROJOS

* Opción gafa alta. GA



45, 45P

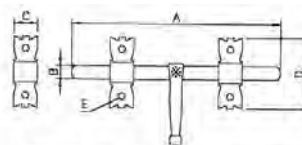

Ref.	A	B	C	D	E
45	180	∅12	15	54	∅4
45-P	125	∅11	15	54	∅4

Medidas en mm.

Estilo 84R

* Opción gafa alta. GA



84R

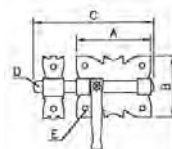

Ref.	A	B	C	D	E
84-R	40	42	65	∅8	∅4
	50	42	80	∅8	∅4
	60	46	95	∅9	∅4
	70	47	106	∅10	∅4
	80	56	124	∅11	∅4
	100	57	160	∅12	∅4

Medidas en mm.

Felipe II 85R



85R

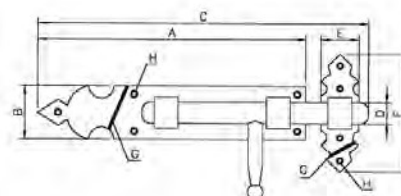

Ref.	A	B	C	D	E	F	G	H
85-R	225	45	280	∅18	32	100	2	∅4

Medidas en mm.



Fabricando en España desde 1886

* Opción Gafa Alta GA

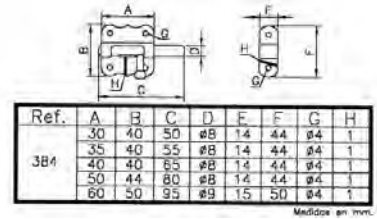

CERROJO GIRATORIO Y PARA SOLDAR

454, 455

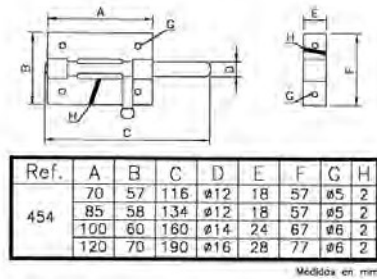
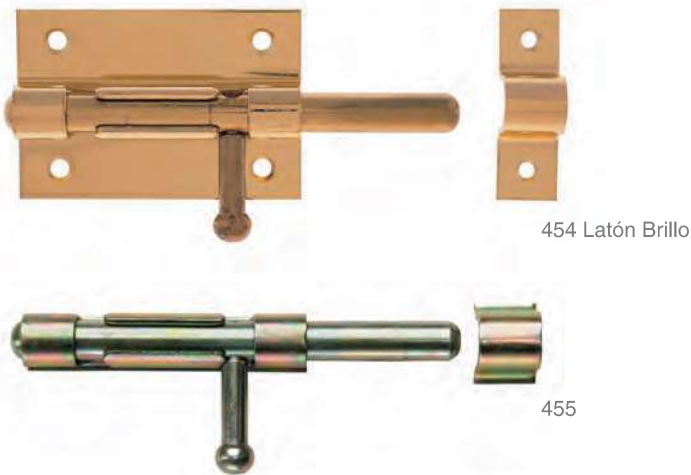

CERROJO GIRATORIO Y PARA SOLDAR CON AGUJERO CANDADO

454C, 455C

